



FEATURES

- 20 WATTS MAXIMUM OUTPUT POWER
- OUTPUT CURRENT UP TO 5.5A
- STANDARD 2.0 X 1.0 X 0.4 INCH PACKAGE
- HIGH EFFICIENCY UP TO 89%
- 4:1 ULTRA WIDE INPUT VOLTAGE RANGE
- SIX-SIDED CONTINUOUS SHIELD
- FIXED SWITCHING FREQUENCY
- CE MARK MEETS 2006/95/EC, 93/68/EEC AND 2004/108/EC
- UL60950-1, EN60950-1 AND IEC60950-1 LICENSED
- ISO9001 CERTIFIED MANUFACTURING FACILITIES
- COMPLIANT TO RoHS EU DIRECTIVE 2002/95/EC

APPLICATIONS

Wireless Network
Telecom/Datacom
Industry Control System
Measurement Equipment
Semiconductor Equipment

OPTIONS

Negative logic Remote On/Off

DESCRIPTION

The FED20W series offer 20 watts of output power from a 2 x 1 x 0.4 inch package. The FED20W series with 4:1 ultra wide input voltage of 9-36 and 18-75VDC and features 1600VDC of isolation, short-circuit and over-voltage protection.

TECHNICAL SPECIFICATION

All specifications are typical at nominal input, full load and 25°C otherwise noted

OUTPUT SPECIFICATIONS		
Output power		20 Watts, max.
Voltage accuracy	Full load and nominal Vin	± 1%
Minimum load		0%
Voltage adjustability	Single output	± 10%
Line regulation	LL to HL at Full Load	Single ± 0.2%
		Dual ± 0.5%
Load regulation	No Load to Full Load	Single ± 0.5%
		Dual ± 1%
Cross regulation (Dual)	Asymmetrical load 25% / 100% FL	± 5%
Ripple and noise	20MHz bandwidth (Measured with a 0.1µF/50V MLCC)	See table
Temperature coefficient		±0.02% / °C, max.
Transient response recovery time	25% load step change	250µS
Over voltage protection	3.3V output	3.9VDC
	5V output	6.2VDC
Zener diode clamp	12V output	15VDC
	15V output	18VDC
Over load protection	% of FL at nominal input	150%, typ.
Short circuit protection		Hiccup, automatics recovery
GENERAL SPECIFICATIONS		
Efficiency		See table
Isolation voltage	Input to Output	1600VDC, min.
	Input(Output) to case	1600VDC, min.
Case grounding		Connect case to -Vin with decoupling Y Cap
Isolation resistance		10 ⁹ ohms, min.
Isolation capacitance		1500pF, max.
Switching frequency		400KHz, typ.
Approvals and standard		IEC60950-1, UL60950-1, EN60950-1
Case material		Nickel-coated copper
Base material		FR4 PCB
Potting material		Epoxy (UL94-V0)
Dimensions		2.00 X 1.00 X 0.40 Inch (50.8 X 25.4 X 10.2 mm)
Weight		27g (0.95oz)
MTBF (Note 1)	BELLCORE TR-NWT-000332	1.620 x 10 ⁶ hrs
	MIL-HDBK-217F	6.590 x 10 ⁵ hrs

INPUT SPECIFICATIONS		
Input voltage range	24V nominal input	9 – 36VDC
	48V nominal input	18 – 75VDC
Input filter		Pi type
Input surge voltage	24V input	50VDC
	100mS max	48V input
Input reflected ripple current	Nominal Vin and full load	20mAp-p
Start up time	Nominal Vin and constant resistive load	Power up 20mS, typ.
		Remote ON/OFF 20mS, typ.
Start-up voltage	24V input	9VDC
	48V input	18VDC
Shutdown voltage	24V input	7.5VDC
	48V input	15VDC
Remote ON/OFF (Note 6)		
(Positive logic)(Standard)	DC-DC ON	Open or 3V < Vr < 12V
	DC-DC OFF	Short or 0V < Vr < 1.2V
(Negative logic)(Option)	DC-DC ON	Short or 0V < Vr < 1.2V
	DC-DC OFF	Open or 3V < Vr < 12V
Input current of remote control pin	Nominal Vin	-0.5mA ~ +0.5mA
Remote off state input current	Nominal Vin	2.5mA

ENVIRONMENTAL SPECIFICATIONS		
Operating ambient temperature		-40°C ~ +66°C (without derating)
		+66°C ~ +105°C (with derating)
Maximum case temperature		105°C
Storage temperature range		-55°C ~ +125°C
Thermal impedance (Note 7)	Nature convection	12°C/Watt
	Nature convection with heat-sink	10°C/Watt
Thermal shock		MIL-STD-810F
Vibration		MIL-STD-810F
Relative humidity		5% to 95% RH

EMC CHARACTERISTICS		
EMI (Note 8)	EN55022	Class A
ESD	EN61000-4-2	Air ± 8KV
		Contact ± 6KV
Radiated immunity	EN61000-4-3	10 V/m Perf. Criteria A
Fast transient (Note 9)	EN61000-4-4	± 2KV Perf. Criteria B
Surge (Note 9)	EN61000-4-5	± 1KV Perf. Criteria A
Conducted immunity	EN61000-4-6	10 Vr.m.s Perf. Criteria A





Model Number	Input Range	Output Voltage	Output Current		Output ⁽⁴⁾ Ripple & Noise	Input Current		Eff ⁽⁴⁾ (%)	Capacitor ⁽⁵⁾ Load max
			Min. load	Full load		No Load ⁽³⁾	Full Load ⁽²⁾		
FED20-24S3P3W	9 – 36 VDC	3.3 VDC	0mA	5500mA	60mVp-p	50mA	934mA	85	18000μF
FED20-24S05W	9 – 36 VDC	5 VDC	0mA	4000mA	75mVp-p	65mA	992mA	88	9600μF
FED20-24S12W	9 – 36 VDC	12 VDC	0mA	1670mA	75mVp-p	22mA	1018mA	86	1650μF
FED20-24S15W	9 – 36 VDC	15 VDC	0mA	1330mA	75mVp-p	22mA	1014mA	86	1050μF
FED20-24D05W	9 – 36 VDC	±5 VDC	0mA	±2000mA	100mVp-p	55mA	992mA	88	±4800μF
FED20-24D12W	9 – 36 VDC	±12 VDC	0mA	±833mA	100mVp-p	30mA	1004mA	87	±825μF
FED20-24D15W	9 – 36 VDC	±15 VDC	0mA	±667mA	100mVp-p	30mA	1005mA	87	±525μF
FED20-48S3P3W	18 – 75 VDC	3.3 VDC	0mA	5500mA	60mVp-p	35mA	467mA	85	18000μF
FED20-48S05W	18 – 75 VDC	5 VDC	0mA	4000mA	75mVp-p	35mA	496mA	88	9600μF
FED20-48S12W	18 – 75 VDC	12 VDC	0mA	1670mA	75mVp-p	15mA	503mA	87	1650μF
FED20-48S15W	18 – 75 VDC	15 VDC	0mA	1330mA	75mVp-p	15mA	501mA	87	1050μF
FED20-48D05W	18 – 75 VDC	±5 VDC	0mA	±2000mA	100mVp-p	35mA	490mA	89	±4800μF
FED20-48D12W	18 – 75 VDC	±12 VDC	0mA	±833mA	100mVp-p	17mA	496mA	88	±825μF
FED20-48D15W	18 – 75 VDC	±15 VDC	0mA	±667mA	100mVp-p	17mA	496mA	88	±525μF

Note:

- BELLCORE TR-NWT-000332. Case 1: 50% Stress, Temperature at 40°C. MIL-HDBK-217F Notice2 @Ta=25 °C, Full load(Ground, Benign, controlled environment)
- Maximum value at nominal input voltage and full load.
- Typical value at nominal input voltage and no load.
- Typical value at nominal input voltage and full load.
- Test by minimum Vin and constant resistive load.
- The ON/OFF control pin voltage is referenced to -Vin. To order negative logic ON/OFF control add the suffix-N (Ex: FED20-48S05W-N)
- Heat sink is optional and P/N: 7G-0020C-F.
- The FED20W series can meet EN55022 Class A with parallel an external capacitor to the input pins. Recommend : 24Vin : NA. 48Vin : 1μF/100V 1210 MLCC.
- An external input filter capacitor is required if the module has to meet EN61000-4-4, EN61000-4-5. The filter capacitor Power Mate suggest: Nippon chemi-con KY series, 220 μF/100V, ESR 48mΩ.

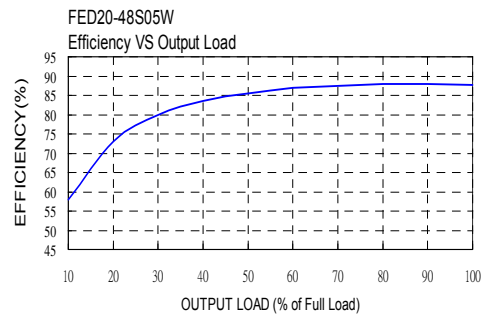
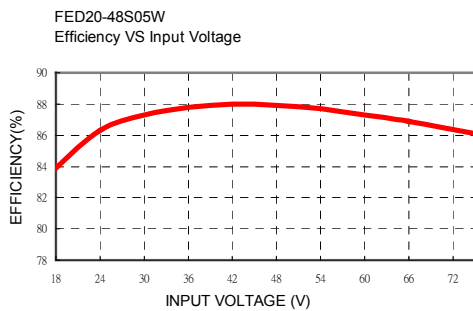
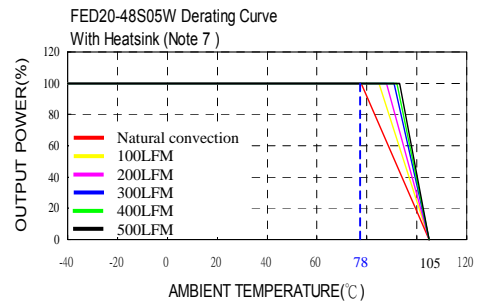
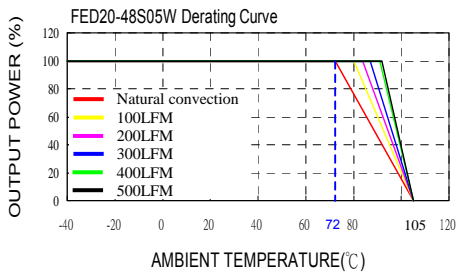

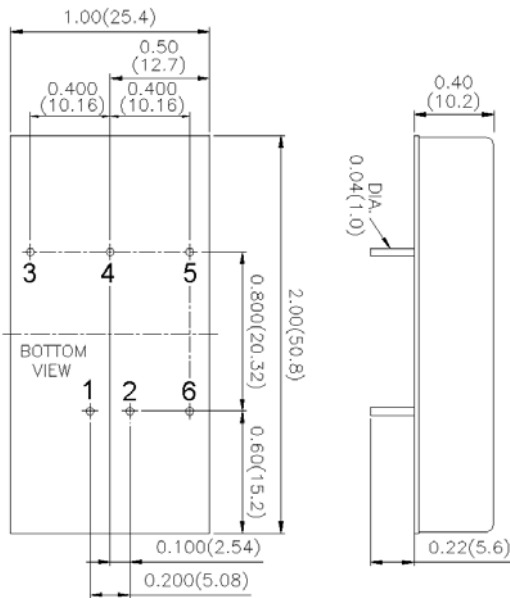

1. All dimensions in Inches (mm)
Tolerance: X.XX±0.02 (X.X±0.5)
X.XXX±0.01 (X.XX±0.25)
2. Pin pitch tolerance ±0.01(0.25)
3. Pin dimension tolerance ±0.004 (0.1)

PIN CONNECTION		
PIN	SINGLE	DUAL
1	+ INPUT	+ INPUT
2	- INPUT	- INPUT
3	+ OUTPUT	+ OUTPUT
4	TRIM	COMMON
5	- OUTPUT	- OUTPUT
6	CTRL	CTRL

EXTERNAL OUTPUT TRIMMING

Output can be externally trimmed by using the method shown below.

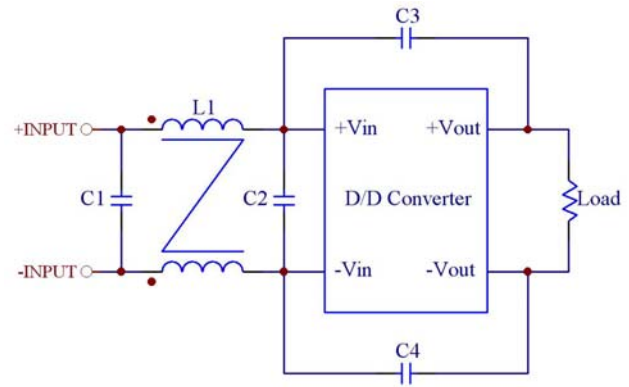
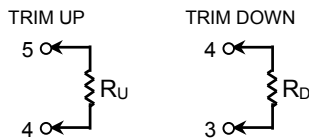

Recommended Filter for EN55022 Class B Compliance

The components used in the above figure, together with the manufacturers' part numbers for these components, are as follows:

	C1	C2	C3	C4	L1
FED20-24xxxW	4.7µF/50V 1812 MLCC	N/A	1000pF/2KV MLCC	1000pF/2KV MLCC	450µH Common Choke PMT-048
FED20-48xxxW	2.2µF/100V 1812 MLCC	2.2µF/100V 1812 MLCC	1000pF/2KV MLCC	1000pF/2KV MLCC	325µH Common Choke PMT-050

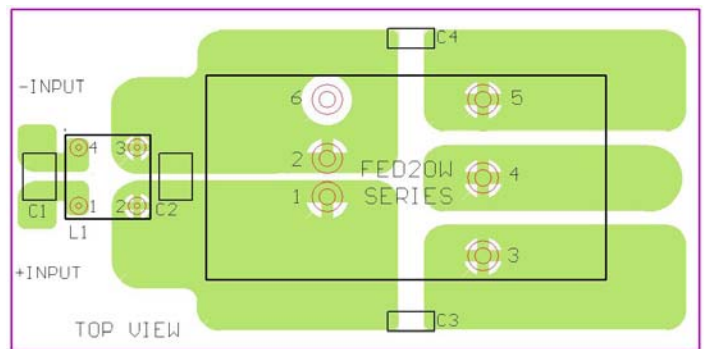

Recommended EN55022 Class B Filter Circuit Layout